

Assembly instructions for 6FT & 7ft STRG Module.

Fasteners.

STRG-6.1 & STRG-7

Tools needed:
 (1) Hammer
 (1) Power drill
 (1) Level
 (1) Phillips Screwdriver
 *Suggested 18 gauge Brad Gun with 1/4" brad nails will make install easier.

Parts List:

→ (16) 1/2" screws for attaching hinges to the sides and the doors.

→ (20) nails

→ (6) 1 1/6" break away screws for attaching the door knobs to the doors and drawer handles to the drawer.

→ (16) Adjustable Shelf Holders

→ (4) Door Knobs

→ (16) 7/16" camlock screws for securing camlocks.

→ (1) Drawer handles

→ (8) Hinge Covers

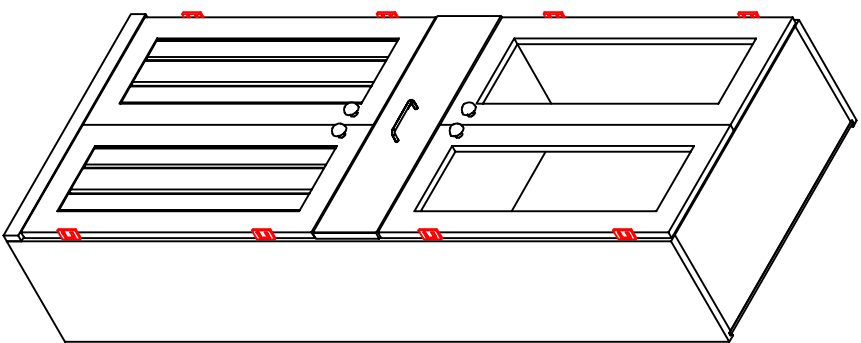

6FT VERSION

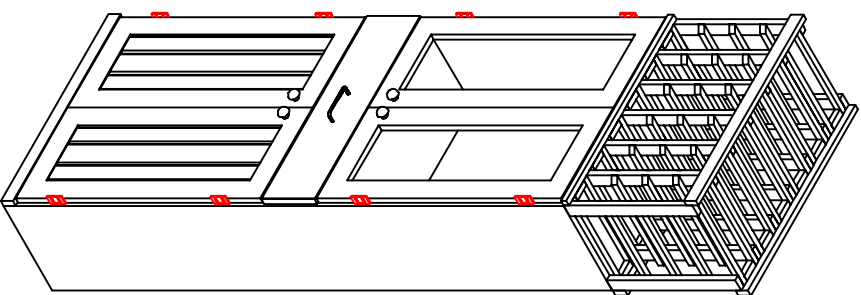

7FT VERSION

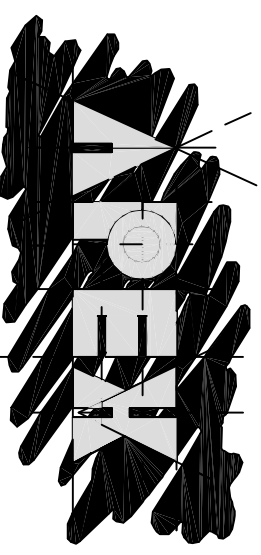

WINE CELLARS & RACKING SYSTEMS
 SAUNAS STEAMBATHS
 PHONE: 425-398-0565
 FAX: 425-398-0803

Assembly Instructions for 6ft & 7ft STRG Module. STRG-6.1 & STRG-7 Racking.

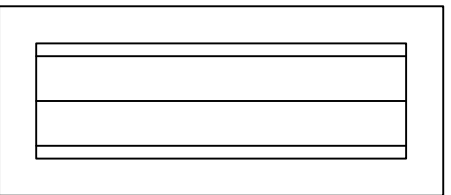
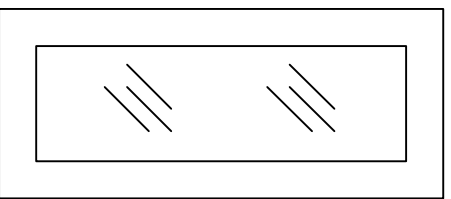
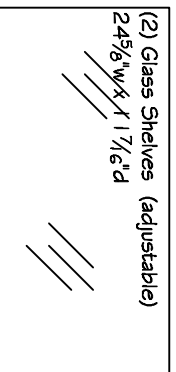
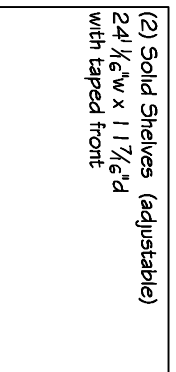
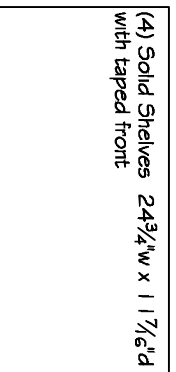

(2) 3/4" Plywood Sides 68⁵/₈"h x 11⁵/₈"d with tapered front

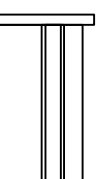
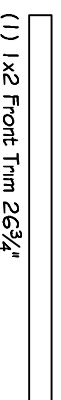
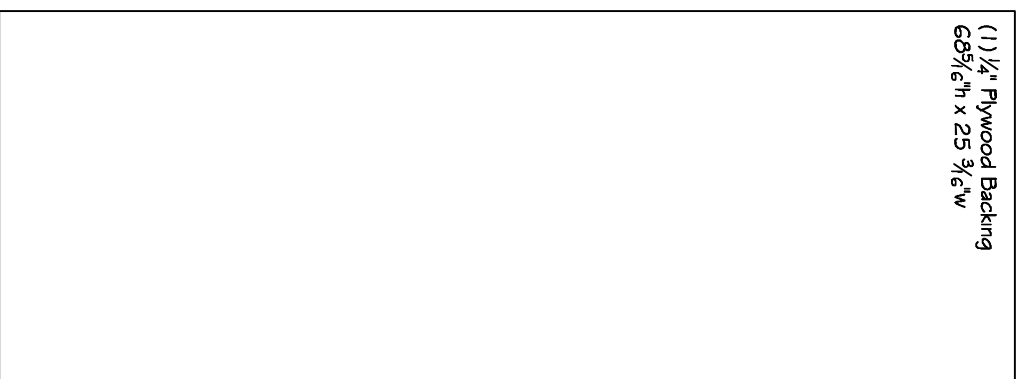
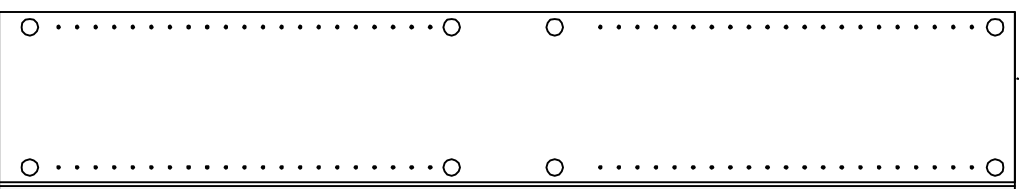

Assembly instructions for 7ft STRG Module. Racking.

STRG 6.1 & STRG-7

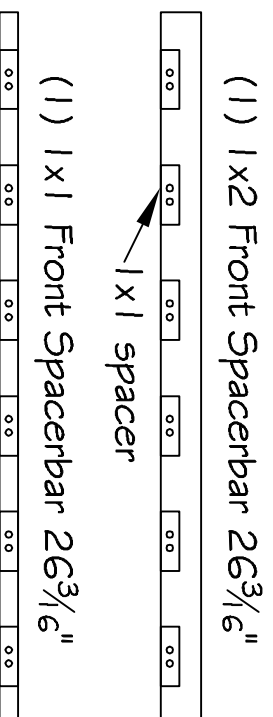
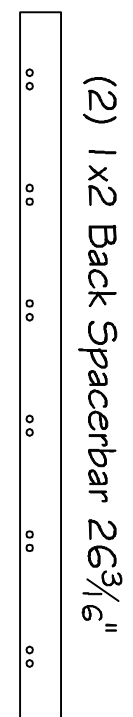
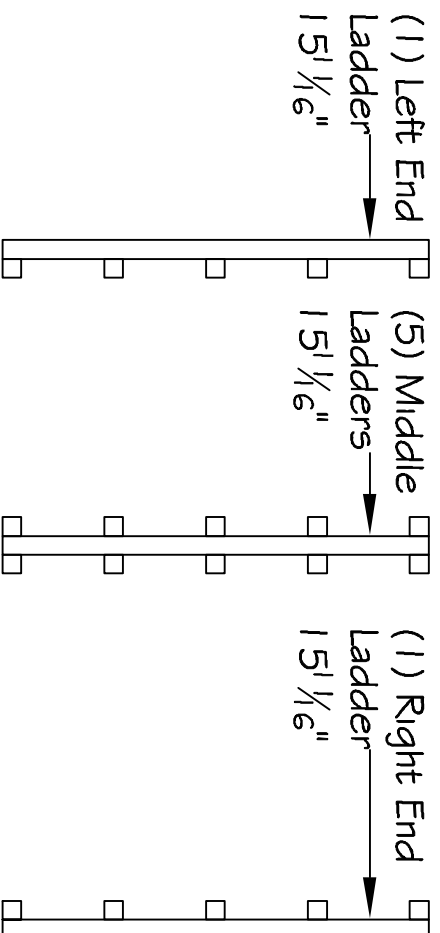

Side view of spacerbars "up" position

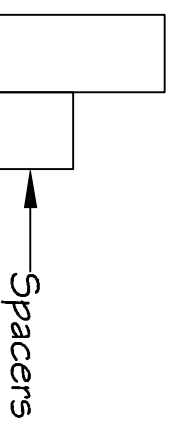

Side view of spacerbars "down" position

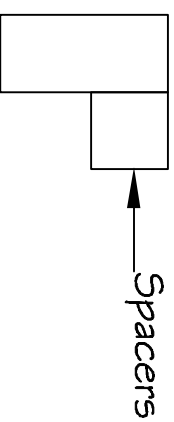

Note the BACK spacerbar is determined by the nails showing from the 1x2 side used to attach the 1x2 to the 1x1 spacer. FRONT spacerbar has the nails showing on the 1x1 spacer.

step 1

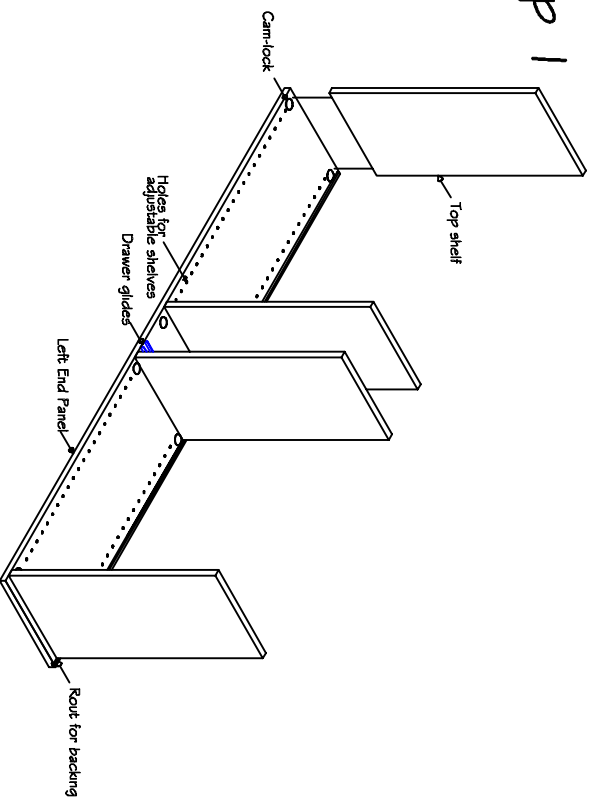

Step 1: (Attaching shelves to right end panel)
Set the right end panel on the floor. Find all four of the 24³/₄" wide shelves. Start at the top and line up the holes in the side of the shelf with the screws sticking out of the side panel. Secure shelf in place by screwing "cam-lock" clockwise to lock the shelf in place.

step 2

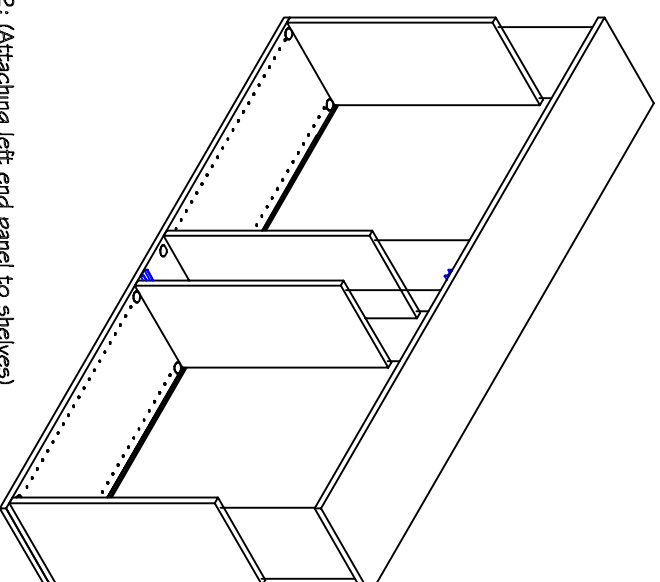

Step 2: (Attaching left end panel to shelves)
Lay left end panel on top of shelves and secure in place by screwing "cam-lock" clockwise to lock panel in place.

step 3

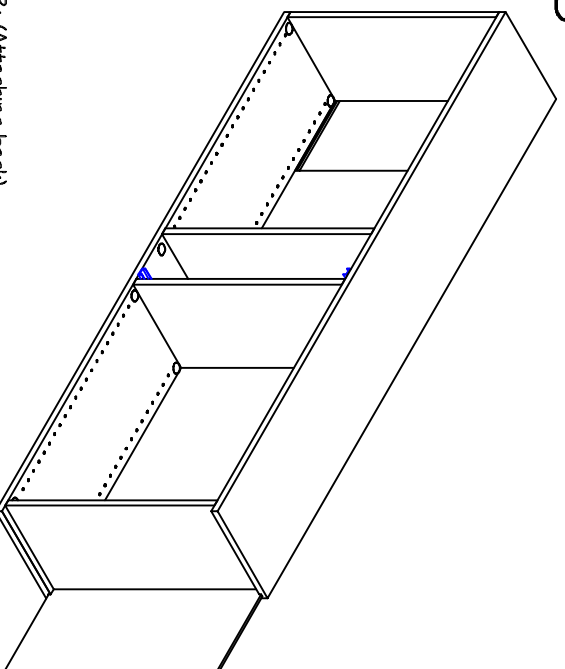

Step 3: (Attaching back)
Find 1/4" plywood back and insert into grooves near the back of the end panels from the bottom or top. Slide back piece all the way through so it covers the top and bottom shelves. Nail through the back at the top and bottom shelf and 30" from the top to secure in place.

step 4

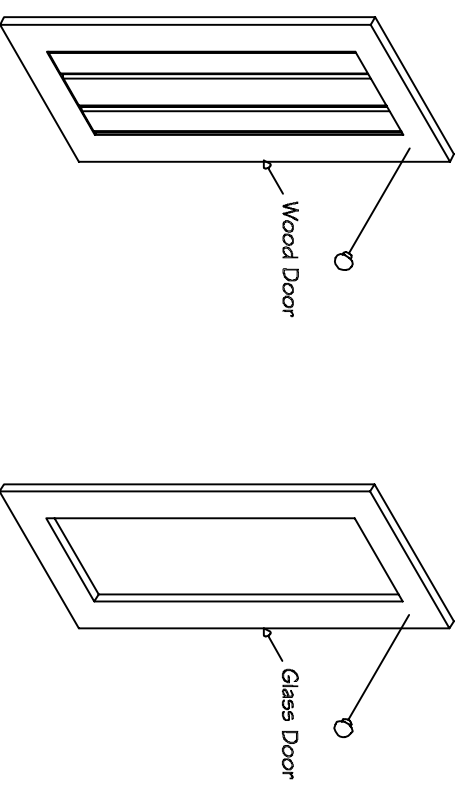

Step 4: (Attaching knobs to doors)
Attach the door knobs to the four doors using the break away screws in the pre-drilled holes from the back side of the door.

step 5

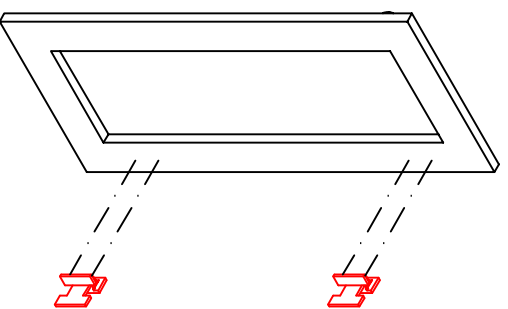
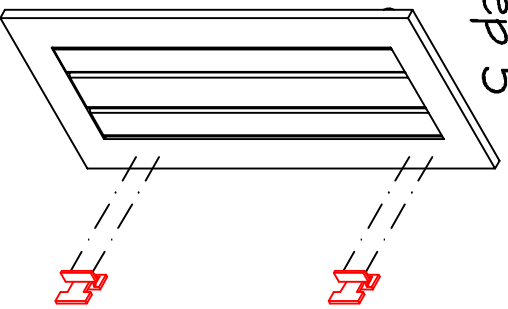

Step 5: (Attaching hinges to doors)
Attach the black hinges to the back side of the four doors with the $\frac{1}{2}$ " screws.

step 6

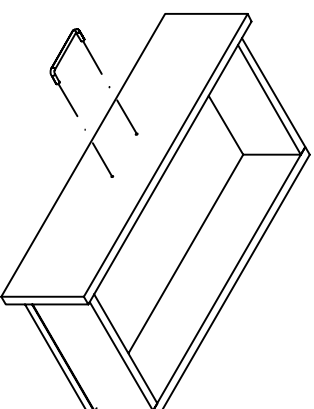

Step 6: (Attaching handle to drawer)
Attach the drawer handle to the drawer using the break away screws in the pre-drilled holes from the back side of the drawer.

step 7

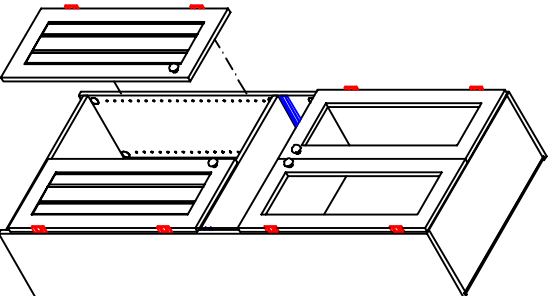

Step 7: (Attaching the doors to the side panels)
Take one door with hinges attached and place the holes of the hinges over the holes in the side panel. Open the door so you have access to the hole. Using the $\frac{1}{2}$ " screws, secure door in place. Doors with glass go on top. After the doors are in place put the $\frac{3}{8}$ " x $1\frac{1}{2}$ " hinge covers on to cover the screws.

step 8

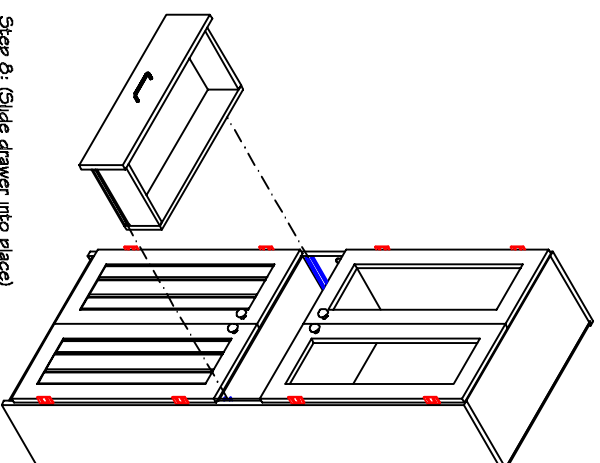

Step 8: (Slide drawer into place)
Drawer will be pre-assembled. Line the drawer up with the drawer glides already attached to the end panels and slide into place until the glides on the drawer and the end panels lock together.

step 9

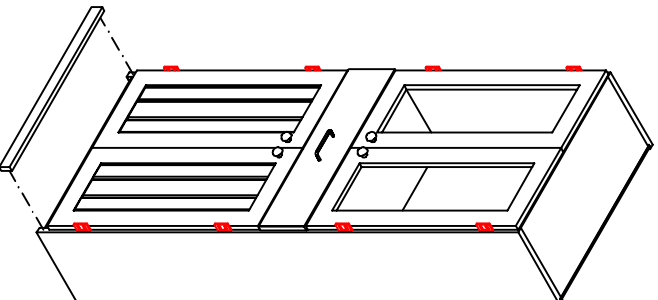

Step 9: (Attaching front trim)
Take the 26 $\frac{3}{8}$ " long x 1 $\frac{1}{2}$ " tall trim piece and place under bottom doors. Nail through the front into the side panels to secure in place.

step 11

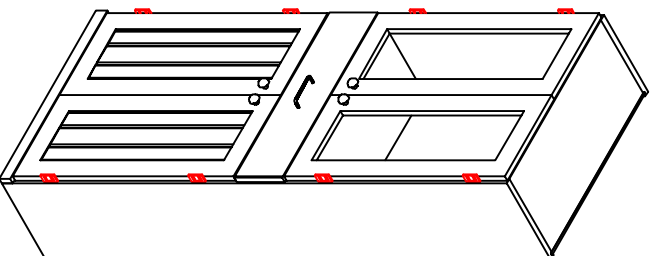

Step 11: (Finish Cabinet)
Final step if six foot module was purchased. If seven foot module was purchased, move on to step 12.

step 10

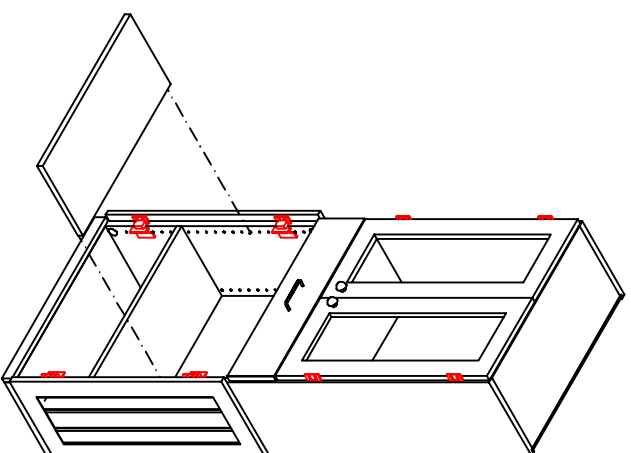

Step 10: (Placing shelf holders and shelving)
Insert the (16) adjustable shelf holders into the 30mm holes at the front and back. Place the wood shelves in the bottom cavity and the glass shelves in the top cavity.

step 12

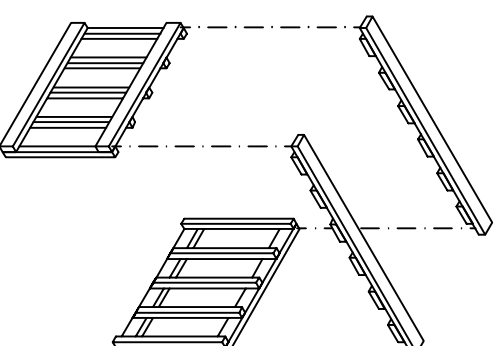

Step 12: (Attaching Back Spacerbars)
Place the right and left end ladders on the floor, making sure the angled rails are facing the floor. On the 1st and 5th rungs, nail the end ladders to a 1x2 BACK spacerbar. The spacerbars need to be "up" so that the small block of wood is towards the bottom.

step 13

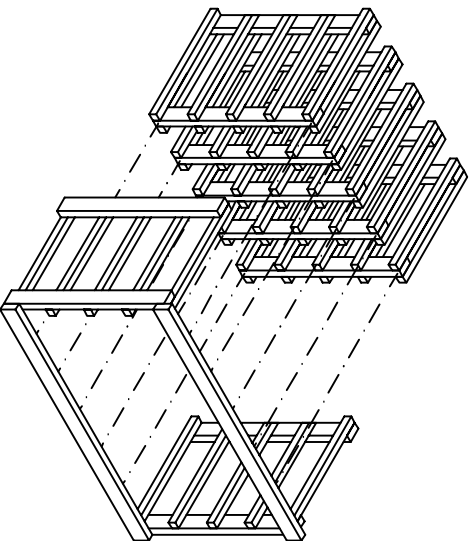

Step 13: (Attaching Middle Ladders to Back Spacerbars)
Stand up the rack. Insert the 5 middle ladders into the slots of the spacerbar as shown. Nail each middle ladder onto the spacerbars as shown with the nails provided.

step 14

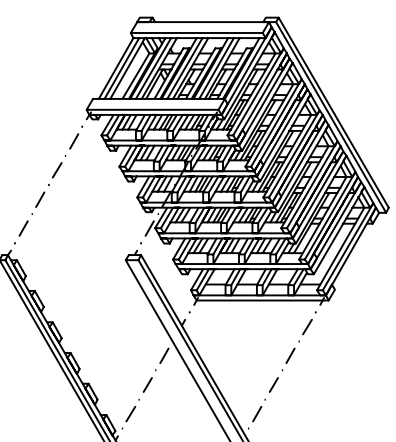

Step 14: (Attaching 1x2 & 1x1 front spacerbars)
Starting from the bottom, place a 1 x 1 spacerbar on the 1st rung and a 1 x2 spacerbar on the 5th rung. Place one nail into each ladder to secure into place. All but the bottom spacerbar needs to be "up" so that the small block of wood is towards the floor.

step 15

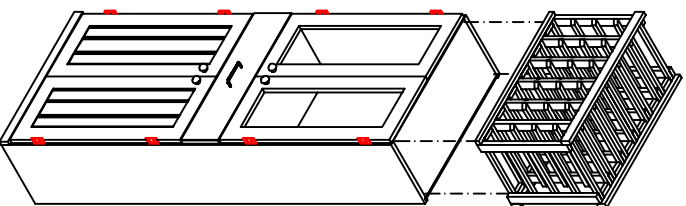

Step 15: (Attaching rack to cabinet)
Use two screws on the bottom 1x1 of each end ladder to attach rack to cabinet.

step 16

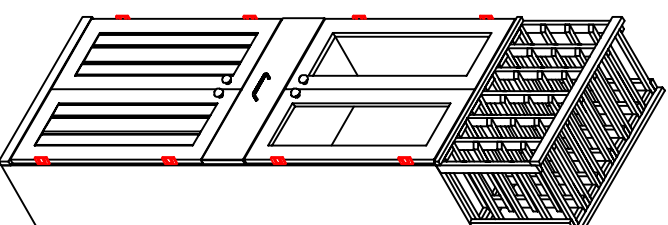

Step 16: (Finish)
Fasten to the wall through the back spacerbar using the 2 1/2" screw and using a level to make sure the rack is mounted square on the wall.

Fastener Placement Guide

(20) nails
 -Nail two into each end of the front trim piece. Use 1/2 on the back, four at the top, bottom and 30" from the top.

