

Assembly instructions for 7ft B/D Module.

Fasteners.

B/D-7

Tools needed:

- (1) Hammer
- (1) Power drill
- (1) Level
- *Suggested 18 gauge Brad Gun with 1/4" brad nails will make install easier.

Parts List:



- 6) 2 1/2" Phillips screws for attaching to wall.
- (3) 1 1/4" Joining Screws to attach to other modules.
- (56) 1/4" Shelf Screws

(30) nails



(8) Drywall Inserts

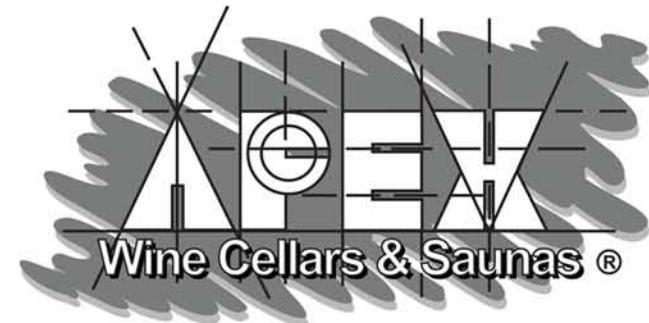
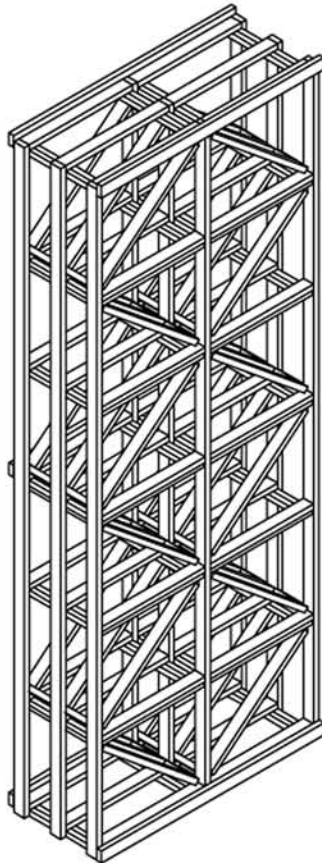

Assembly instructions for 7ft B/D Module. Racking.

B/D-7

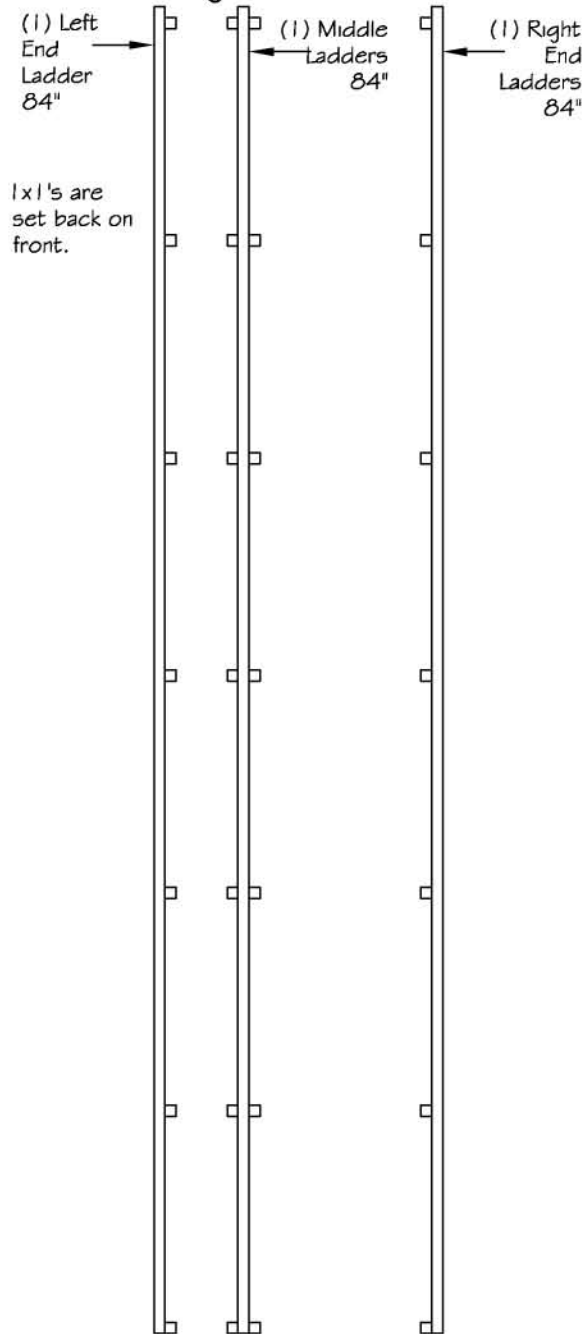
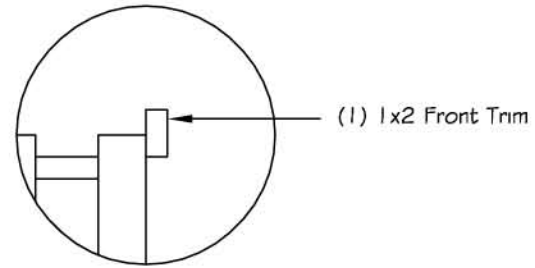

Diagram of 1x2 Front Trim in the "up" position



(5) 1x2 Trim (2) for front (3) for back $32\frac{3}{8}"$



(14) Pre-assembled shevles 15"

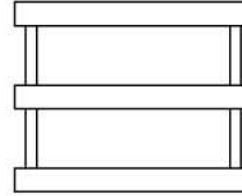

(12) Pre-assembled diagonals $18\frac{5}{8}"$

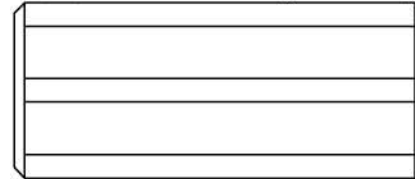

step 1

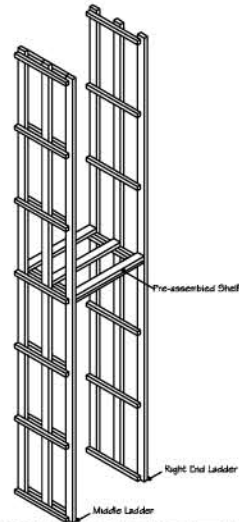

Step 1: (Attaching middle shelf to right end ladder and middle ladder)
Arrange the right end ladder and the middle ladder making sure the set back on the rungs are facing forward. Place one pre-assembled shelf on the fourth rung. The front of the shelf has a 1x1 trim piece fastened under the 1x2 cross support. From the inside, either brad nail or screw the shelves onto the rung in two places.

step 2

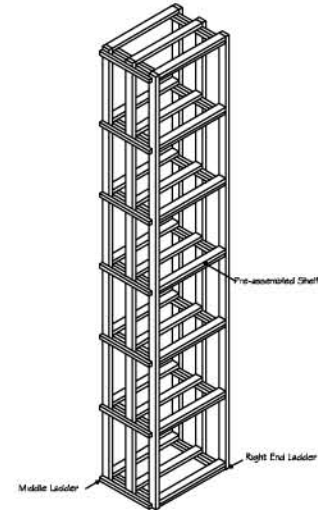

Step 2: (Attaching remaining shelves to right end ladder and middle ladder)
Place the other six shelves onto the remaining six rungs and attach in the same way as in Step 1. Make sure the shelves with the trim pieces are facing the front.

step 3

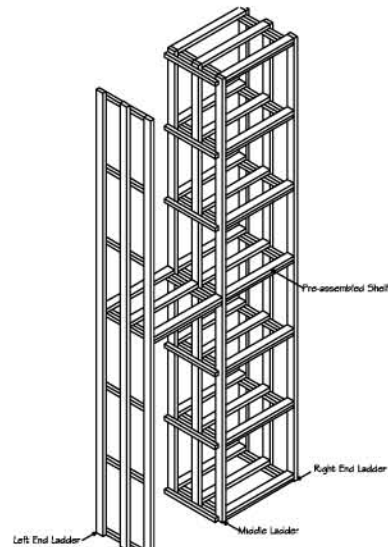

Step 3: (Attaching middle shelf to left end ladder and middle ladder)
Take the left end ladder and move it into place on the left side in the same way as the right end ladder. Place one pre-assembled shelf on the fourth rung. The front of the shelf has a 1x1 trim piece fastened under the 1x2 cross support. From the inside, either brad nail or screw the shelves onto the rung in two places.

step 4

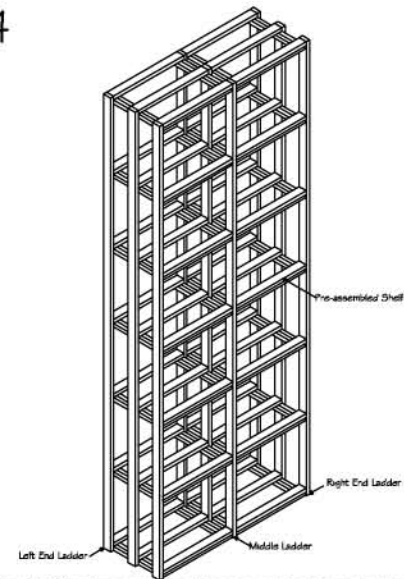

Step 4: (Attaching remaining shelves to end ladder and middle ladder)
Place the other six shelves onto the remaining six rungs and attach in the same way as in Step 1. Make sure the shelves with the trim pieces are facing the front.

step 5

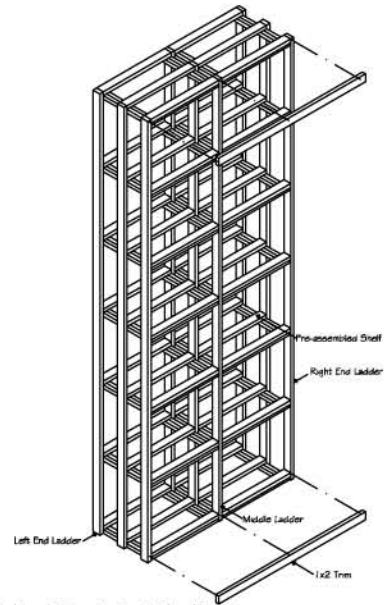

Step 5: (Attaching 1x2 trim to front of rack)
Use two of the 1x2x24 1/2" trim pieces and attach them to the top and bottom. Both of these should be placed so the remaining trim is up.

step 6

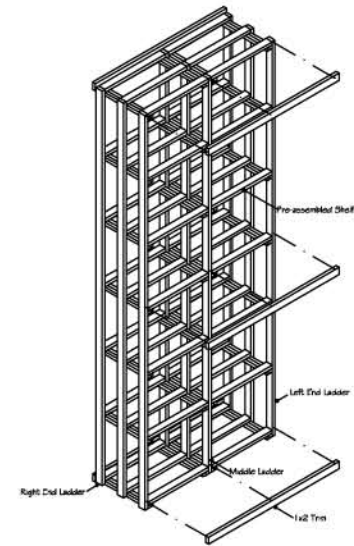

Step 6: (Attaching 1x2 trim to back of rack)
Take the last three 1x2x24 1/2" trim pieces and attach them to the 1st, 5th and 8th shelf from the bottom to the top. All of these should be placed so the remaining trim is up. The exposed area of the trim will be used to screw through to apply the rack to the wall.

step 7

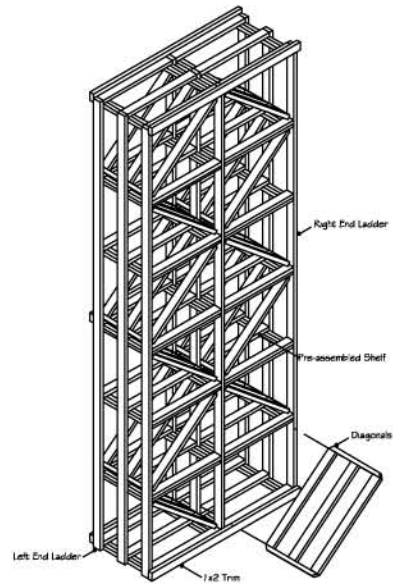

Step 7: (Inserting diagonals)
Take all eight pre-assembled diagonals and insert them into the eight openings.

step 8 Finish

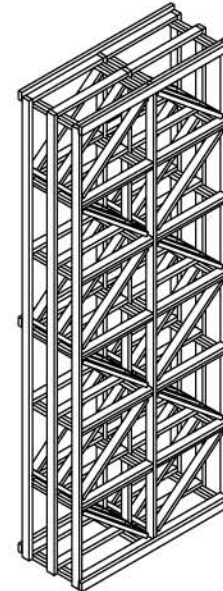

Step 8: (Finish)
Fasten to the wall through the back supports using the 2 1/2" screws.

Fastener Placement Guide

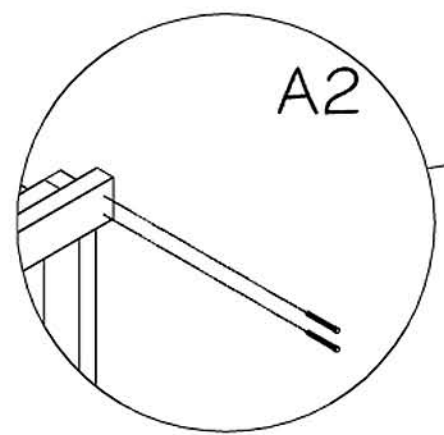

A2

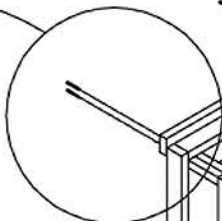

A2

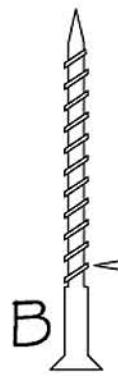

(30) nails
-Nail one at every point where the front and back trim intersect a ladder as shown.

(56) shelf screws
-Place shelf on 1x1's and screw through 1x1's from the side.

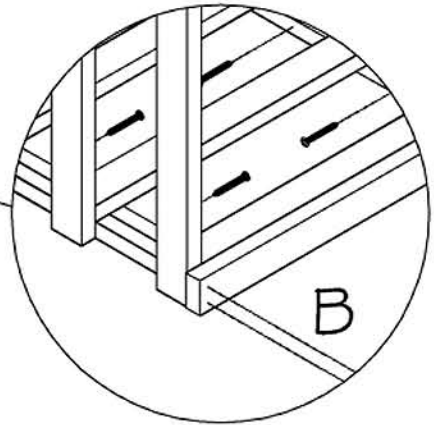

B

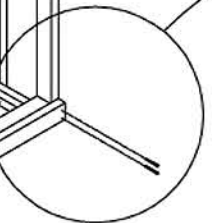

A1

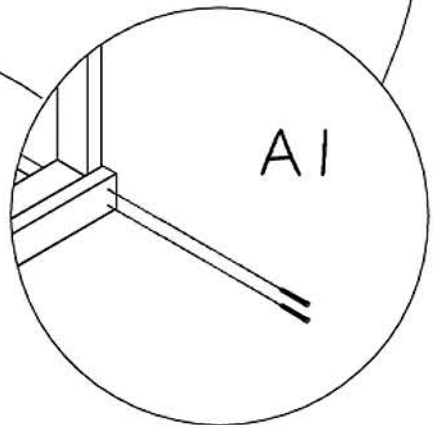

A1

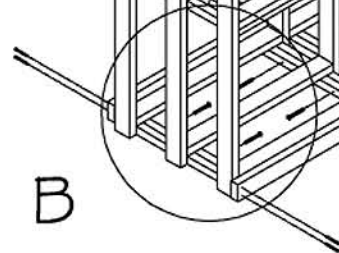

B

